

HR97 Motion & Presence Sensor

INSTALLATION INSTRUCTIONS

Active Infrared Motion & Presence Sensor for Automatic Door Control

We would like to extend our thanks to you for purchasing this sensor. We at Hotron Ireland Ltd. are committed to providing you quality products and excellent customer service.

Before installing this sensor, **PLEASE READ THE FOLLOWING INSTRUCTIONS CAREFULLY:**

Section 1 General Description / Features

The HR97 is a microprocessor controlled active infrared motion and presence detector which serves two purposes. First, it is designed to Activate any automatic door made today. Second, it provides presence detection close to All types of Automatic doors.

- Wide & Narrow pattern width of the sensor is high density adjustable by twin revolving lends units.
- Pattern depth and width are adjustable using mounting height, dip switches, pattern width and pattern angle adjustments.
- Frequency is select in four channels.
- Self-Diagnostic means the sensor continuously Monitors it self.
- Snow Mode Switch ensures against false operation caused by snow, insects, etc.
- Microprocessor provides programmable Presence Timer (180, 60, 15, or 2 seconds).

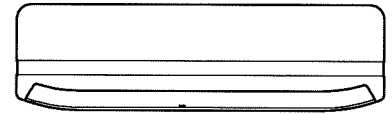

Section 2 Parts Identification

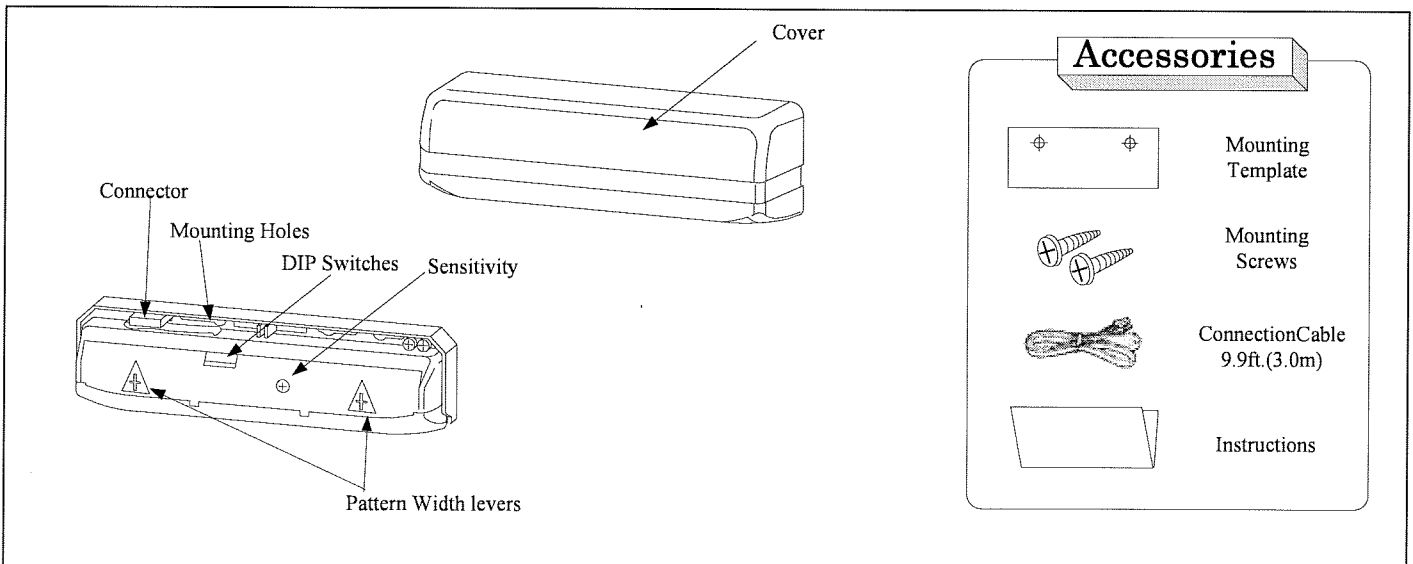

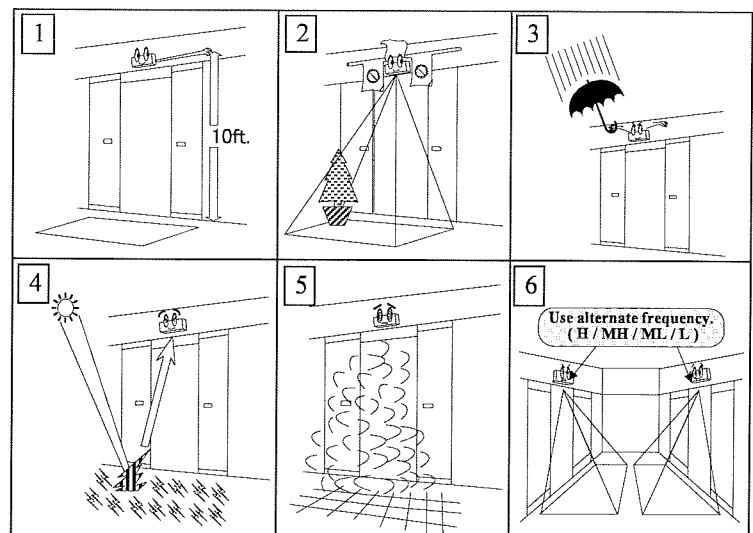

Section 3 Mounting Information

- 1 Do not mount higher than 10ft. (3m).
- 2 Do not leave any objects which may move in the detection pattern.
- 3 Do not mount where rain or snow will fall directly on unit.
- 4 Do not mount in a place where reflection of sunlight will shine on unit.
- 5 Do not mount in a humid or steamy environment.
- 6 Do not mount five devices in proximity to each other. When using from 2 to 4 devices in proximity, use alternate frequency settings as shown. (Maximum 4 sensors)

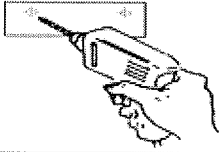
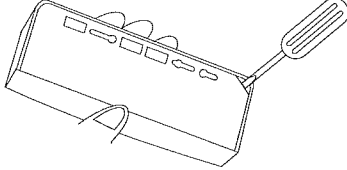
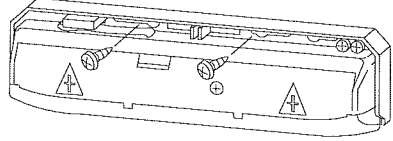
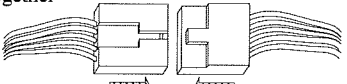
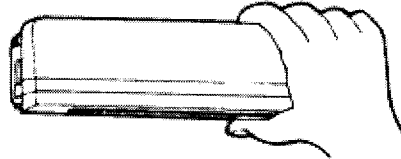

Section 4 Mounting and Wiring

<p>1 Using the mounting template provided, drill mounting and wire holes.</p> 	<p>2 Remove cover using a driver.</p> 	<p>3 Fasten unit with mounting screws provided.</p> 
<p>4 Connect wiring. Push amp connectors tightly together</p>  <p>Red & Black = Power (Non Pole) Yellow = Normally Open Green = Normally Closed White = Com.</p>	<p>5 Set desired sensor parameters as noted in Sections 5 & 7.</p> <div style="border: 1px solid black; padding: 5px; margin-top: 10px;"> <p>⇒ Section 5 DIP Switch Settings ⇒ Section 7 Adjusting Detection Pattern</p> </div>	<p>6 Place cover on sensor and clean the sensor.</p> 
<p> NOTE: For maximum pattern depth and width, mount the HR97 as high as possible and use the maximum pattern angle. (10°)</p>		

Section 5 Dip Switch Settings

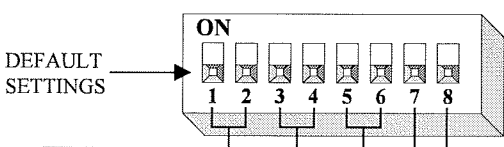
 <p>DEFAULT SETTINGS →</p> <table border="1" style="width: 100%; border-collapse: collapse; margin-top: 10px;"> <thead> <tr> <th style="width: 20%;">① Presence Timer</th> <th style="width: 20%;">② Pattern Depth (Rows)</th> <th style="width: 20%;">③ Frequency</th> <th style="width: 20%;">④ Monitor mode</th> <th style="width: 20%;">⑤ Self Monitoring</th> </tr> </thead> <tbody> <tr> <td>2 Sec <input type="checkbox"/> 1 <input type="checkbox"/> 2</td> <td>4 R <input type="checkbox"/> 1 <input type="checkbox"/> 2 <input type="checkbox"/> 3 <input type="checkbox"/> 4</td> <td>H <input type="checkbox"/> 5 <input type="checkbox"/> 6</td> <td>Snow <input type="checkbox"/> 7</td> <td>ON <input type="checkbox"/> 8</td> </tr> <tr> <td>15 Sec <input type="checkbox"/> 1 <input type="checkbox"/> 2</td> <td>3 R <input type="checkbox"/> 1 <input type="checkbox"/> 2 <input type="checkbox"/> 3</td> <td>MH <input type="checkbox"/> 5 <input type="checkbox"/> 6</td> <td><input type="checkbox"/> 7</td> <td>OFF <input type="checkbox"/> 8</td> </tr> <tr> <td>60 Sec <input type="checkbox"/> 1 <input type="checkbox"/> 2</td> <td>2 R <input type="checkbox"/> 1 <input type="checkbox"/> 2</td> <td>ML <input type="checkbox"/> 5 <input type="checkbox"/> 6</td> <td>Normal <input type="checkbox"/> 7</td> <td></td> </tr> <tr> <td>180 Sec <input type="checkbox"/> 1 <input type="checkbox"/> 2</td> <td>1 R <input type="checkbox"/> 1</td> <td>L <input type="checkbox"/> 5 <input type="checkbox"/> 6</td> <td></td> <td></td> </tr> </tbody> </table>	① Presence Timer	② Pattern Depth (Rows)	③ Frequency	④ Monitor mode	⑤ Self Monitoring	2 Sec <input type="checkbox"/> 1 <input type="checkbox"/> 2	4 R <input type="checkbox"/> 1 <input type="checkbox"/> 2 <input type="checkbox"/> 3 <input type="checkbox"/> 4	H <input type="checkbox"/> 5 <input type="checkbox"/> 6	Snow <input type="checkbox"/> 7	ON <input type="checkbox"/> 8	15 Sec <input type="checkbox"/> 1 <input type="checkbox"/> 2	3 R <input type="checkbox"/> 1 <input type="checkbox"/> 2 <input type="checkbox"/> 3	MH <input type="checkbox"/> 5 <input type="checkbox"/> 6	<input type="checkbox"/> 7	OFF <input type="checkbox"/> 8	60 Sec <input type="checkbox"/> 1 <input type="checkbox"/> 2	2 R <input type="checkbox"/> 1 <input type="checkbox"/> 2	ML <input type="checkbox"/> 5 <input type="checkbox"/> 6	Normal <input type="checkbox"/> 7		180 Sec <input type="checkbox"/> 1 <input type="checkbox"/> 2	1 R <input type="checkbox"/> 1	L <input type="checkbox"/> 5 <input type="checkbox"/> 6			<p>① Presence Timer : Timer is adjustable using switches 1 and 2. 1 to 4 Rows will detect a stationary object for the time period set by the Presence Timer. The timer will reset and begin if <u>any</u> movement is detected.</p> <p>② Pattern Depth (Rows) : To adjust the pattern depth, All Rows (Row 1 to 4) = Presence Dtection</p> <p>③ Frequency : When more then two sensors are used in close proximity to each other, to prevent interference use alternate frequency settings. (H + MH + ML + L = Maximum 4 sensors)</p> <p>④ Monitor Mode : A Snow Mode is available. Snow Mode should only be used in environments with heavy snowfall or other extreme conditions Exit.</p> <p>⑤ Self-Monitoring : "ON"=When power is first supplied to HR97 the sensor automatically performs a Self Diagnosis. (See Section 9)</p>
① Presence Timer	② Pattern Depth (Rows)	③ Frequency	④ Monitor mode	⑤ Self Monitoring																						
2 Sec <input type="checkbox"/> 1 <input type="checkbox"/> 2	4 R <input type="checkbox"/> 1 <input type="checkbox"/> 2 <input type="checkbox"/> 3 <input type="checkbox"/> 4	H <input type="checkbox"/> 5 <input type="checkbox"/> 6	Snow <input type="checkbox"/> 7	ON <input type="checkbox"/> 8																						
15 Sec <input type="checkbox"/> 1 <input type="checkbox"/> 2	3 R <input type="checkbox"/> 1 <input type="checkbox"/> 2 <input type="checkbox"/> 3	MH <input type="checkbox"/> 5 <input type="checkbox"/> 6	<input type="checkbox"/> 7	OFF <input type="checkbox"/> 8																						
60 Sec <input type="checkbox"/> 1 <input type="checkbox"/> 2	2 R <input type="checkbox"/> 1 <input type="checkbox"/> 2	ML <input type="checkbox"/> 5 <input type="checkbox"/> 6	Normal <input type="checkbox"/> 7																							
180 Sec <input type="checkbox"/> 1 <input type="checkbox"/> 2	1 R <input type="checkbox"/> 1	L <input type="checkbox"/> 5 <input type="checkbox"/> 6																								

Section 6 Power

<p>BEFORE APPLYING POWER, READ AND FOLLOW THESE INSTRUCTIONS: When power is applied, the sensor will read and store the environmental optical parameters. This is necessary for Presence Detection to work properly.</p> <ol style="list-style-type: none"> ① CLEAR THE AREA OF ANY UNNECESSARY OBJECTS. ② Apply POWER. ③ Vacate the Detection Pattern immediately. While the sensor sees ANY moving objects in its DETECTION PATTERN, it will not proceed to the following step. ④ DO NOT enter DETECTION PATTERN for 10 seconds (Presence Detection Setting). ⑤ TEST the presence feature, especially near the door. 	<p>When carrying out the following work, TURN OFF THE POWER:</p> <ol style="list-style-type: none"> 1. When the floor conditions change (woolen/rubber). 2. Adjusting pattern or sensitivity.
---	--

Section 7 Adjusting Detection Pattern

Adjust the detection pattern according to the following diagrams:

1. Pattern Angle Adjustment.

SIDE VIEW/DETECTION PATTERN

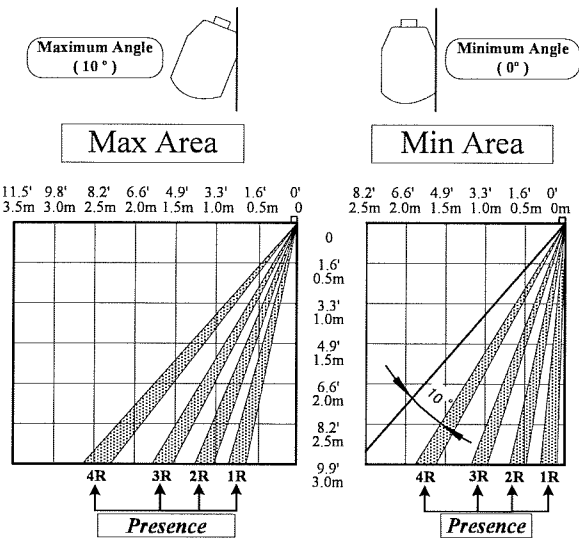

» The body of the sensor can be rotated from 0°~10°(5 Steps)

2. Pattern Width Adjustment

Pattern Adjustments for single and/or double doors by Pattern Width lever.

FRONTAL VIEW/DETECTION PATTERN

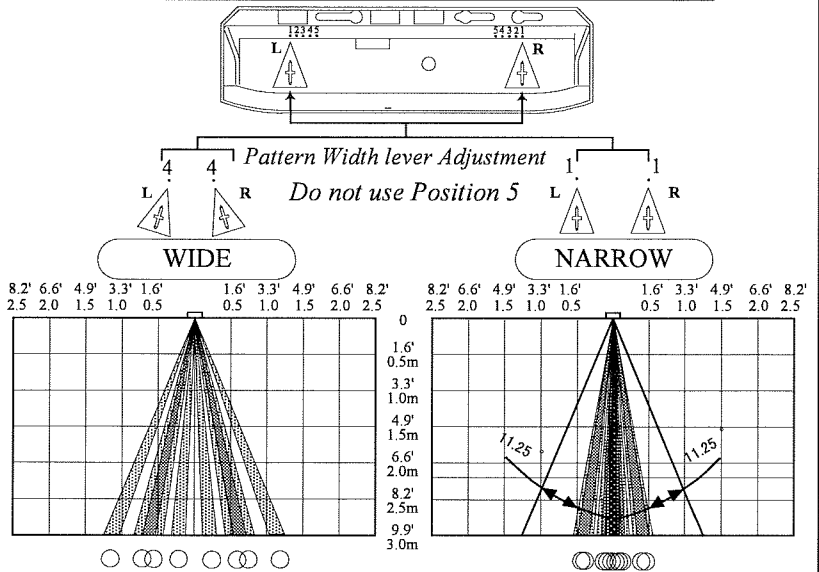

! Detection pattern will vary according to objects, material, color and speed.

Section 8 Verification of Operation

1. After mounting, setting parameters and applying power, walk test unit to verify detection pattern.
2. If the door does not operate properly, recheck the dip switch settings and pattern adjustments.
3. After rechecking, if there is still a problem, adjust the sensitivity.

» Adjust high (clockwise) to increase sensitivity.
 » Adjust low (counter-clockwise) to decrease sensitivity.

! APPLY ONLY SMALL TORQUE

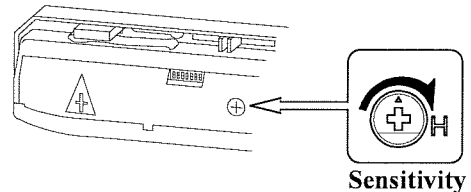

Section 9 Self Monitoring

Infra-red beams are received on the Receiver side of the HR97, then the following occurs. For 12 seconds the relay starts chattering ON/OFF (4 times in 12 sec's) then the relay remains in the ON condition for 60 seconds then the cycle repeats itself. At the same time the Indicator Lamp will switch continuously between RED and GREEN. The door will remain in an Open position throughout.

Relay Output Timing Chart (When no reflection)

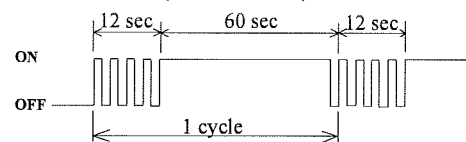

***** **EXTREMELY IMPORTANT** *****

After final set-up, test unit(s) completely to ensure that proper coverage has been achieved (width, depth and location of the pattern must be tested).

After the installation and operational check of the system :

1. Place the proper labels on the door per ANSI/BHMA A156.10. & BS7036.
2. Instruct the owner of the door system operation and how to test it. This should be checked on a daily basis.
3. Instruct the owner on what to do if the door or any of its components become damaged.
4. Strongly recommend to the owner that the complete entry be inspected twice a year as part of the service agreement.

Section 10 Troubleshooting

Problems	Cause	Solution
Door does no operate	Sensor Connector	Tighten connector or reconnect.
	Power Supply	Check that the power supply is properly connected and AC-DC 12&24V.
Door operates intermittently	Sensor is very dusty or covered in water drops, etc.	Clean the sensor. (do not use thinner or alcohol to clean sensor)
	Sensitivity too low	Turn up sensitivity.
	Detection pattern in the wrong position	Alter the detection pattern by changing sensor angle, dip switch setting and/or pattern width adjustments.
Door operates by itself	Sensitivity too high	Turn down sensitivity.
	Another sensor is too close by	Change the frequency to each sensor.
	Sensor detects the door movement	If the indicator LED is an Orange color, adjust the pattern depth angle away from the door.
	There is a cloth mat in the monitored	Turn the sensor power off and then on again, and allow it 10 seconds
	Detection pattern too far in front of the door, detecting people passing by	Adjust the detection pattern - move it closer to the door
The condition of the monitored area is varying. • Dusty / Dirty • Snow	The condition of the monitored area can change due to heavy dust or dirty heavy snow of footprints being left in fresh snow, this will cause the door to open sometimes. Set the Stationary Time-out to a short times.	

Section 11 Technical Data

Section 12 External Dimensions

Model	HR97 Motion & Presence Sensor
Detection Method	Active Infrared Detection (Motion & Presence)
Maximum Installed Height	10ft. (3m)
Pattern Adjustments	Wide or Narrow Pattern Width (Side lever 1 to 4 Position) 1 to 4 Rows Pattern Depth (Dip Switches) Angle Adjustment θ to 1θ in 5 steps (Body Angle) Sensitivity (Potentiometer)
Detection Beams	8 Beams * 4 Rows = 32 Beams
Presence Detection	All Rows (Row 1 to 4) → by Presence Timer
Power Supply	AC-DC 12 to 24V ± 10%
Power Consumption	AC24V-3VA , AC 12V-3VA DC24V-75mA , DC12V-150mA
Output Contact	Form C Relay : DC50V 0.1A (Resistor load) Yellow Wire : Normally Open Green Wire : Normally Closed White Wire : Common
Output Holding Time	Approx. 0.5 seconds
Presence Timer	Limits of 180, 60, 15 and 2 seconds All Rows (Row 1 to 4)
LED Indication	RED-Detecting , GREEN-Standby , ORANGE-Hunting Door Switch between RED and GREEN-Abnormal
Protection	IP54 (IEC60529)
Temperature Range	-4°F to 140°F (-20°C to 60°C)
Weight	0.77 lbs. (0.35kg)
Color	Black (Painting is possible)
Accessories	Cable : 9.9ft (3.0m) , Mounting Template , Installation Instructions, Mounting Screws

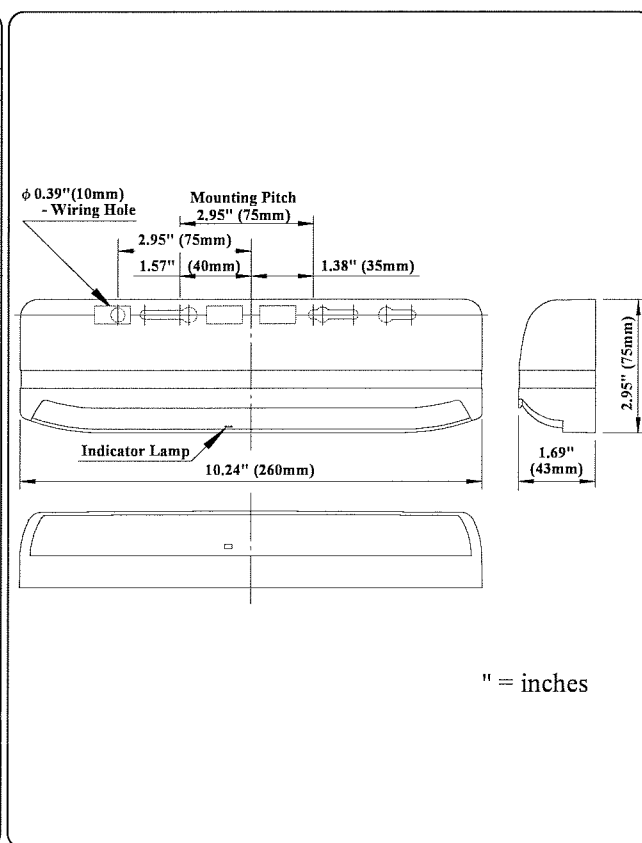

Section 13 Warranty

HOTRON Ireland Ltd. guarantees its products to be free from manufacturing defects for 3 years from date of installation. Unless HOTRON Ireland Ltd. is notified of the date of installation, the warranty will be in effect for 3 years from the date of shipment from our factory. If, during the first 3 years, our motion detector or support device fails to operate and has not been tampered with or abused, the unit can be returned prepaid to the factory and it will be repaired free of charge. After 3 years, the unit will be repaired for a nominal service charge. This limited warranty is in lieu of all other warranties, expressed or implied, including any implied warrantability of merchantability, and no representative or persons authorized to assume for HOTRON Ireland any other liability in connection with the sale of our products. All warranties are limited to the duration of this written limited warranty. In no event shall HOTRON Ireland be liable for any special, incidental, consequential or other damages arising from any claimed breach of warranty as to its products or services.

The HR97 is manufactured in Japan by : HOTRON CO.,LTD.



HOTRON CO.,LTD.

HOTRON CO., LTD.
1-11-26 Hyakunin-cho, Shinjuku-ku, Tokyo, Japan
Phone: +81-3-5330-9221 Fax: +81-3-5330-9222
URL: <http://www.hotron.com>

Hotron Ireland Ltd.
26 Dublin Street (2nd Floor), Carlow, Ireland
Phone: 353-(0)59 9140345 Fax: 353-(0)59 9140543
URL: <http://www.hotron.com>